

OGNJEVARNE-ooH Hladno cinkana (senzimir) L=3m, d=1.5mm
75/60*1.5 PERF.HL.C.

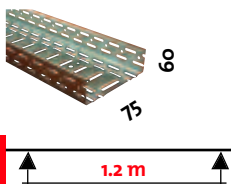

OGNJEVARNE-ooH Hladno cinkana (senzimir) L=3m, d=1.5mm
100/60*1.5 PERF.HL.C.

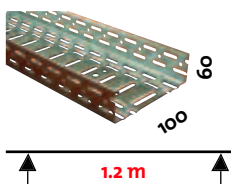

OGNJEVARNE-ooH Hladno cinkana (senzimir) L=3m, d=1.5mm
200/60*1.5 PERF.HL.C.

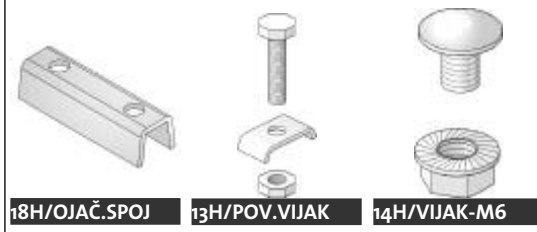
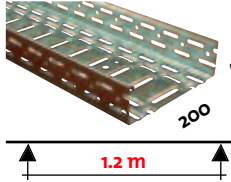

OGNJEVARNE-ooH Hladno cinkana (senzimir) L=3m, d=1.5mm
300/60*1.5 PERF.HL.C.

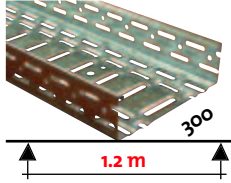

OGNJEVARNE-ooH Hladno cinkana (senzimir) L=3m, d=1.5mm
400/60*1.5 PERF.HL.C.

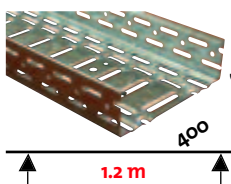

19H/KLIK-KONZ
KCLBS 100
KCLBS 200
KCLBS 300
KCLBS 400

12H/STROP.NOS | **20H/KLIK-SPOJ**





OPOZORILO ZA OGNJEVARNE KABELSKÉ LESTVE

- Ognjevarne kabelske lestve se podpirajo na max. 1.2 m
- Pokrovi se v sistemu ognjevarnih lestev **ne smejo** uporabljati
- Stenski nosilec mora biti podprt tudi iz zunanje strani
- Maximalna obtežitev lestve je 20 kg/m

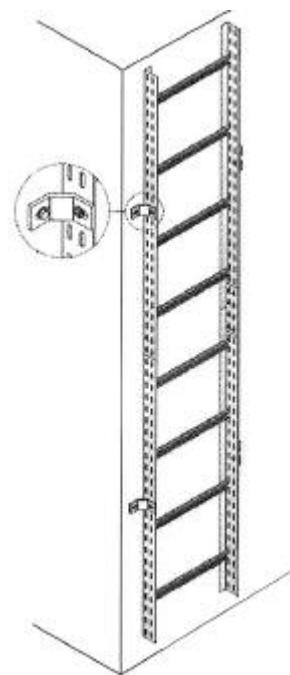
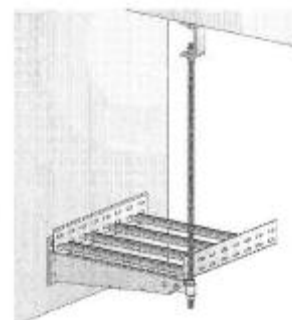
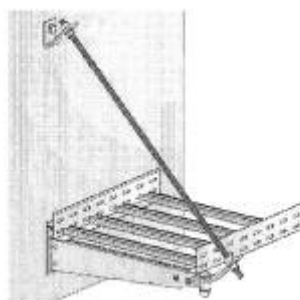
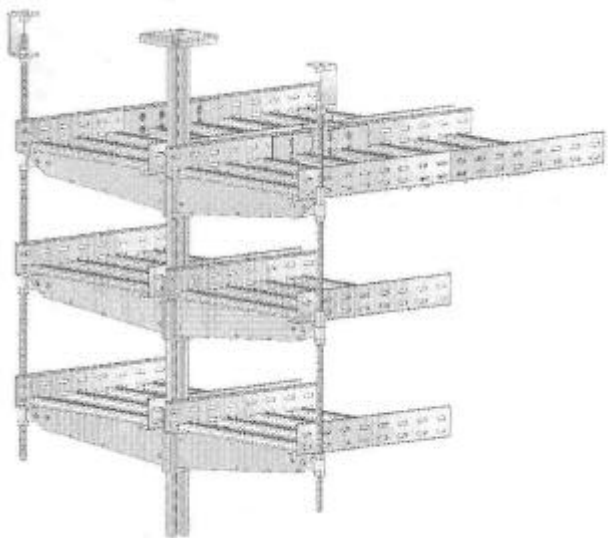

OGNJEVARNE-01H Hladno cinkana (senzimir) L=3m
200/60 LEST.HL.C.

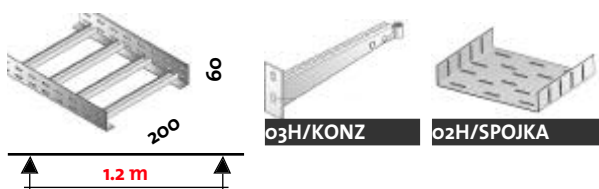

OGNJEVARNE-01H Hladno cinkana (senzimir) L=3m
300/60 LEST.HL.C.

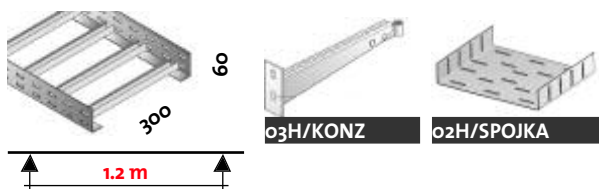

OGNJEVARNE-01H Hladno cinkana (senzimir) L=3m
400/60 LEST.HL.C.

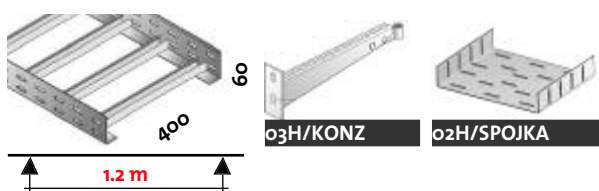

06H/DRŽALO	07H/DRŽALO	08H/DRŽALO	09/DRŽALO
13H/POV.VIJAK	14H/VIJAK-M6	15H/VIJAK-M10	16H/PODL-M10
17H/MAT-M10	12H/STROP.NOS		
10H/NAV-P.M10	11H/SPOJ.-M10	HSLE CL 300	
		HSLE CL 500	
		HSLE CL 1000	

Ognjevarne doze Ego WKE2-5 IP54 (WKE200-400 IP66)

WEK2 86020201 100 x 100 x 50 5 x 6 ²	WEK3 86020301 115 x 115 x 66 5 x 10 ²	WEK4 86020401 165 x 165 x 76 5 x 16 ²	WEK5 86020501 256 x 171 x 106 15 x 6 ²	86010201 290 x 215 x 107	M20 23162001 M25 23162501 M32 23163201 M40 23164001	M20 23062001 M25 23062501 M32 23063201 M40 23064001
		WEK4 86021401 8 x 6 ²				

